

HVCY-3433EES



3433 PLCC6 系列产品 / Products Series

具有高发光效率、高一致性、高稳定性、高可靠性，主要用于汽车应用

High luminous efficiency, consistency, stability and reliability, it is mainly used in automobile applications.

特征

- 外观：白色PPA塑料，荧光硅胶封装
- 50% I_v 视角：120°
- 颜色：Cx=0.56,Cy=0.42（CIE1931）
- 资格：通过了AEC-Q102 & IEC 60810可靠性测试

Features

- Package: Colored diffused silicone in white PPA cup
- Viewing angle at 50% I_v : 120°
- Color: Cx=0.56,Cy=0.42 (acc.to CIE1931)
- Qualifications: Passed reliability test per AEC-Q102 & IEC 60810 requirement

应用

- 信号灯
- 汽车内外部照明应用

Applications

- Signaling
- Interior and exterior lighting for automotive

订购信息 / Ordering Information

型号 Type	发光强度 Luminous Intensity I _v @ I _f =140mA	订单编号 Ordering Code
HVCY-3433EES- XXXX - XX - XX 亮度档 Brightness 色度坐标 Chromaticity Coordinate 电压档 Forward Voltage	3.55 -7.10 cd	XXXXXX

备注

■ 亮度档

单个最小包装只装有同一个亮度档次的产品，具体分档信息请见第4页

例如：HVCY-3433EES-CBDB-XX-XX，单个卷盘中的产品只有CB、DA、DB中的某一档

■ 色度坐标档

具体信息请见第5页

■ 正向电压档

单个最小包装只装有同一个正向电压档次的产品，具体分档信息请见第4页

例如：HVCY-3433EES-XXXX-XX-47，单个卷盘中的产品只有4、5、6、7中的某一档

Note

■ Brightness Grouping

Only one brightness group will be packed in each reel. Please refer to page #4 for details.

E.g.: HVCY-3433EES-CBDB-XX-XX, means only one bin of CB, DA or DB is in each reel.

■ Chromaticity Coordinate Grouping

Please refer to page #5 for details.

■ Forward Voltage Groups

Only one forward voltage group will be packed in each reel. Please refer to page #4 for details.

E.g.: HVCY-3433EES-XXXX-XX-47, means only one bin of 4, 5, 6 or 7 is in each reel.

极限参数 / Maximum Ratings

参数 Parameters	符号 Symbol	数值 Rating	单位 Unit
结温 / Junction Temperature	T_j	125	°C
正向电流 / Forward Current ($T_s=25^\circ\text{C}$)	I_f	250	mA
峰值正向电流 Peak Forward Current ($t \leq 10\mu\text{s}$; $D=0.005$; $T_s=25^\circ\text{C}$)	I_{fp}	750	mA
反向电压 / Reverse Voltage ($T_s=25^\circ\text{C}$)	V_r	12	V
抗静电能力 Electrostatic Discharge (HBM)	V_{ESD}	不可施加反向电压 / not designed for reverse operation	V
操作温度 / Operating Temperature	T_{opr}	-40 ~ +110	°C
储存温度 / Storage Temperature	T_{stg}	-40 ~ +110	°C

特性 / Characteristics ($T_s = 25^\circ\text{C}$; $I_f = 140\text{ mA}$)

参数 Parameters		符号 Symbol	数值 Rating	单位 Unit
色坐标 / Chromaticity coordinates acc. to CIE 1931	typ.	C_x	0.56	nm
		C_y	0.42	
50 % I_v 下的视角 / Viewing Angle at 50 % I_v	typ.	2Φ	120	°
	min.	V_f	2.90	V
	typ. max	V_f V_f	3.30 4.10	V V
反向电流 / Reverse Current ($V_R=12\text{V}$)	typ.	I_r	不可施加反向 电压 / not designed for reverse operation	uA
	max.	I_r		uA
实际热阻值 (PN结-环境) / Real Thermal Resistance (Junction / Ambient)	max.	$R_{th JA_{real}}$	40	K/W
实际热阻值 (PN结-焊点) / Real Thermal Resistance (Junction / Solder Point)	max.	$R_{th JS_{real}}$	33	K/W

亮度分档 / Brightness Grouping ($T_s = 25\text{ }^\circ\text{C}$; $I_f = 140\text{ mA}$)

档次 Grouping	发光强度 Luminous Intensity I_v (min.)	发光强度 Luminous Intensity I_v (max.)	光通量 Luminous Flux Φ_v (typ.)
CB	3.55 cd	4.50 cd	12.10 lm
DA	4.50 cd	5.60 cd	15.20 lm
DB	5.60 cd	7.10 cd	19.10 lm

正向电压分档 / Forward Voltage Grouping ($T_s = 25\text{ }^\circ\text{C}$; $I_f = 140\text{ mA}$)

档次 Grouping	正向电压 Forward Voltage V_f (min.)	正向电压 Forward Voltage V_f (max.)
4	2.90 V	3.20 V
5	3.20 V	3.50 V
6	3.50 V	3.80 V
7	3.80 V	4.10 V

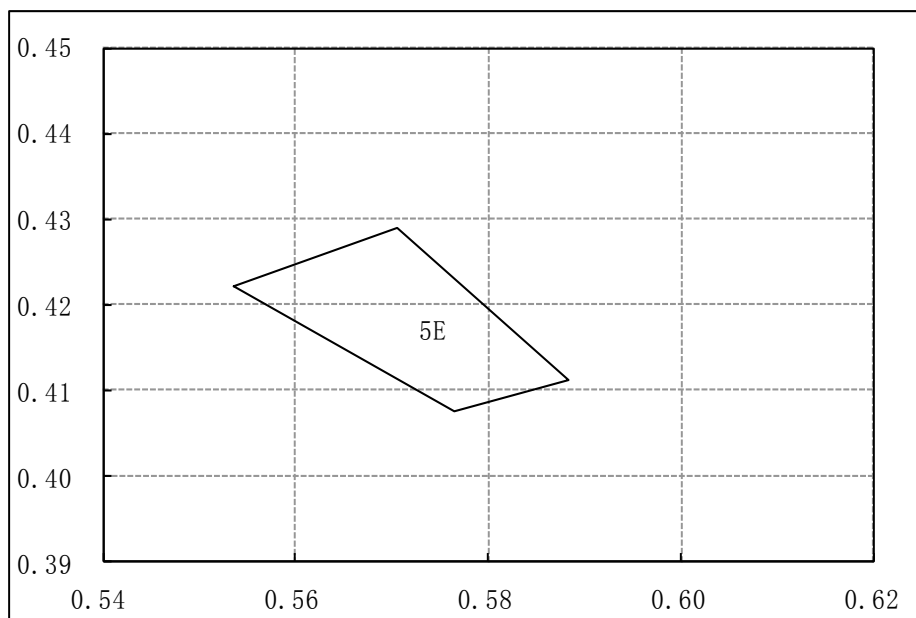
颜色色度分档 / Colour Chromaticity Groups ($T_s = 25\text{ }^\circ\text{C}$; $I_f = 140\text{ mA}$)

5E	
X	Y
0.5536	0.4221
0.5705	0.4289
0.5764	0.4075
0.5883	0.4111

标签信息 / Information on Label

例 / E.g.: CB-5E-4

亮度档 Brightness	色度坐标 Chromaticity Coordinate	正向电压 Forward Voltage
CB	5E	4

相对发射光谱 - $V(\lambda)$ = 标准人眼视觉曲线

Relative Spectral Emission - $V(\lambda)$ = Standard Eye Response Curve

$I_{rel} = f(\lambda)$; $T_s = 25\text{ }^\circ\text{C}$; $I_f = 140\text{ mA}$

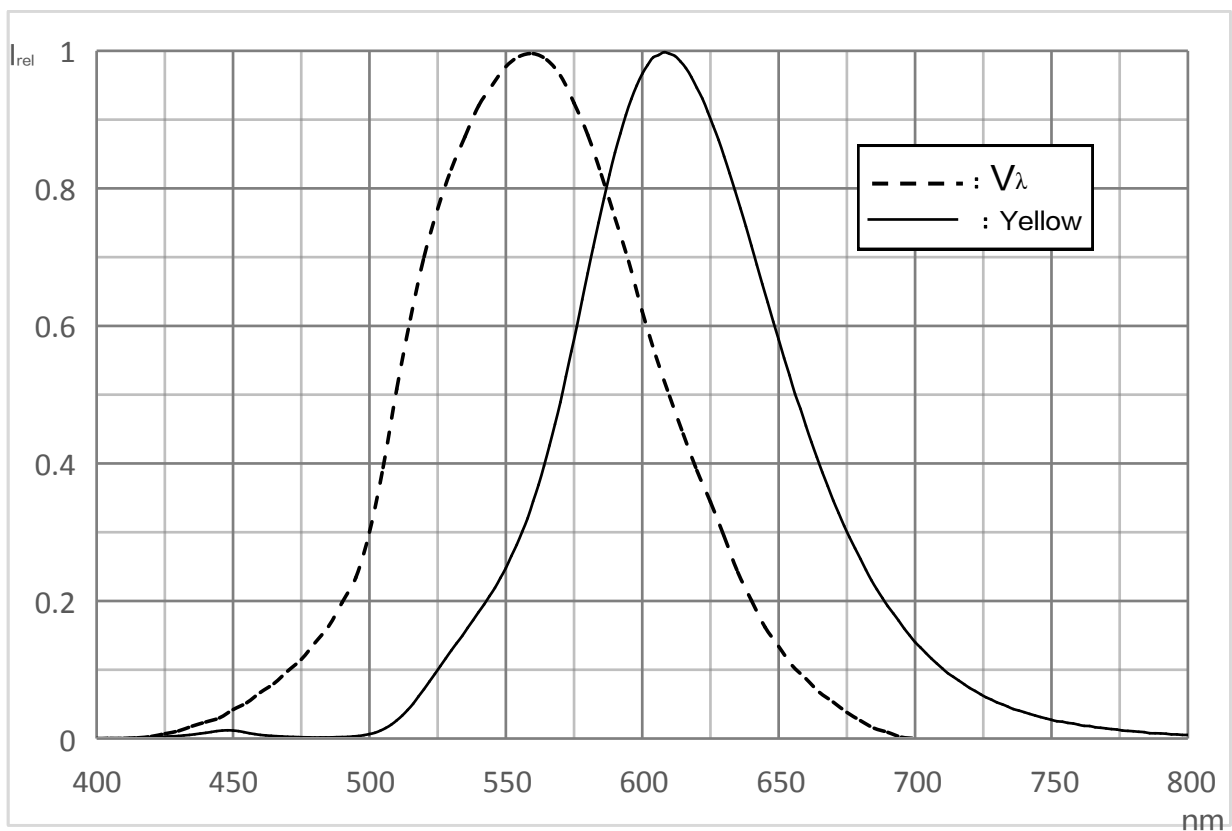

辐射特性 / Radiation Characteristics

$I_{rel} = f(\phi); T_s = 25\text{ }^\circ\text{C}$

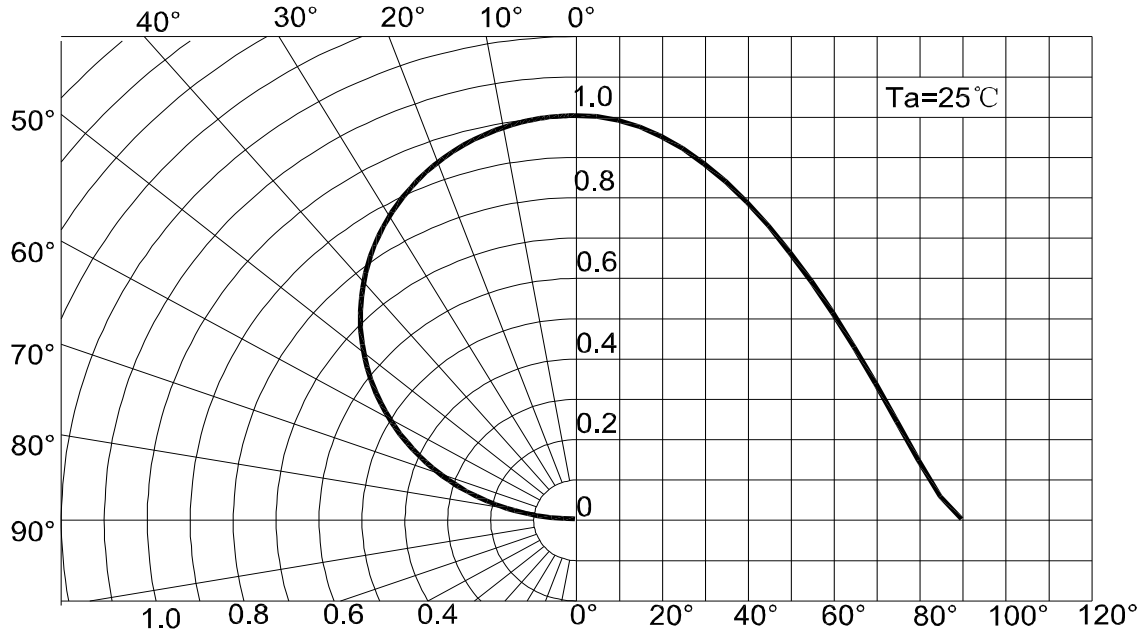

正向电流 / Forward Current

$I_f = f(V_f); T_a = 25\text{ }^\circ\text{C}$

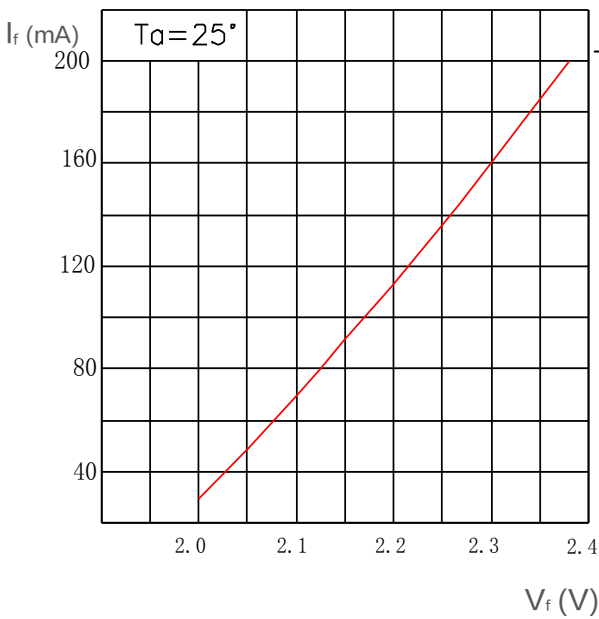

相对亮度特性曲线 / Relative Luminous Intensity

$I_v/I_v(140\text{ mA}) = f(I_f); T_a = 25\text{ }^\circ\text{C}$

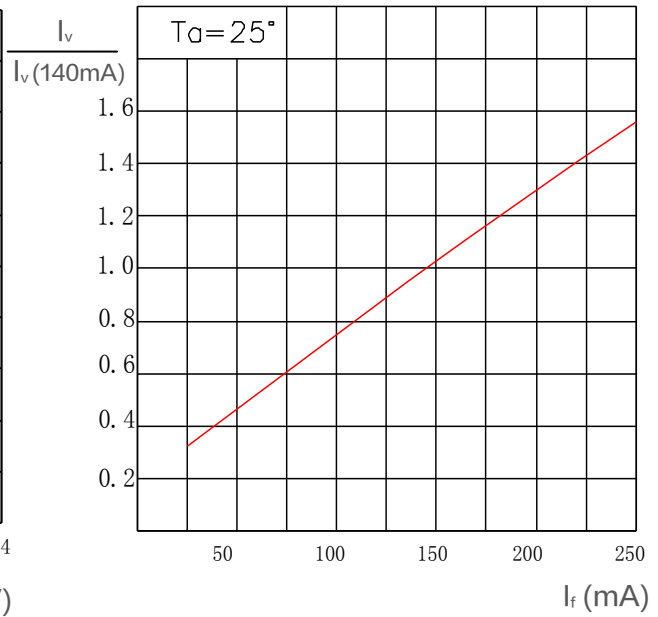

色坐标数据表 / Chromaticity coordinate shift

$\Delta Cx, \Delta Cy = f(I_f); T_s = 25^\circ C$

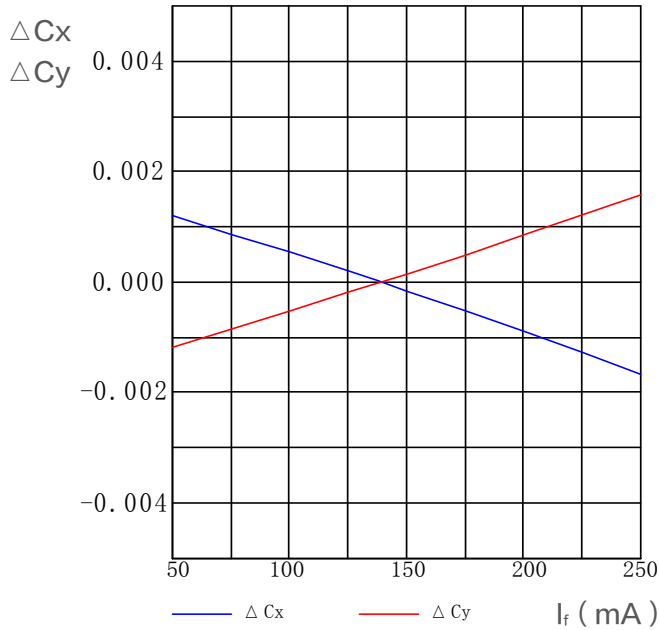

相对正向电压 / Relative Forward Voltage

$\Delta V_f = V_f - V_f(25^\circ C) = f(T_j); I_f = 140\text{ mA}$

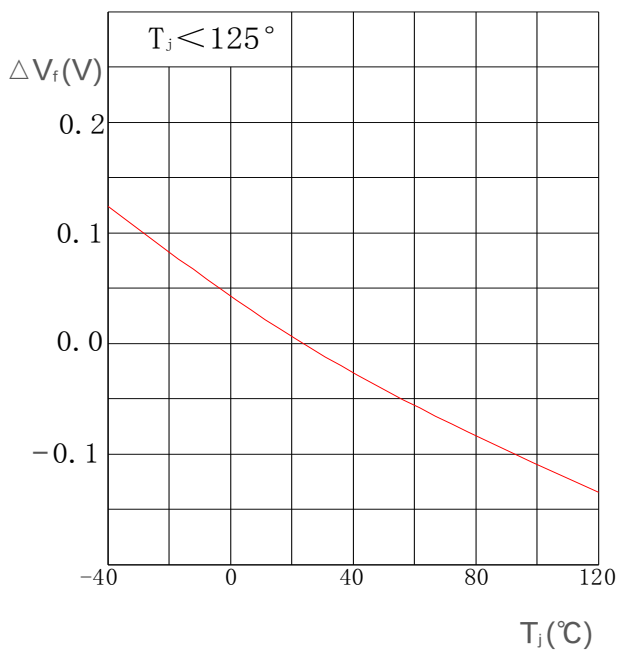

相对发光强度 / Relative Luminous Intensity

$I_v / I_v(25^\circ C) = f(T_j); I_f = 140\text{ mA}$

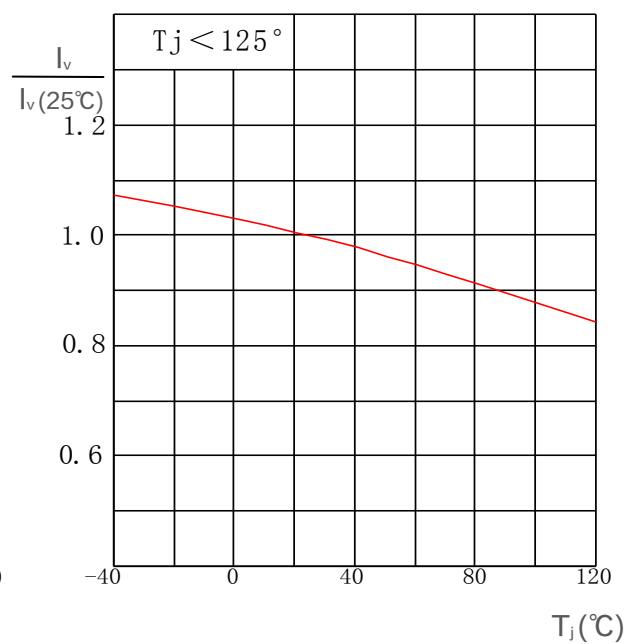

色坐标数据表/Chromaticity coordinate shift

$\Delta Cx, \Delta Cy = f(I_f); I_f = 140mA$

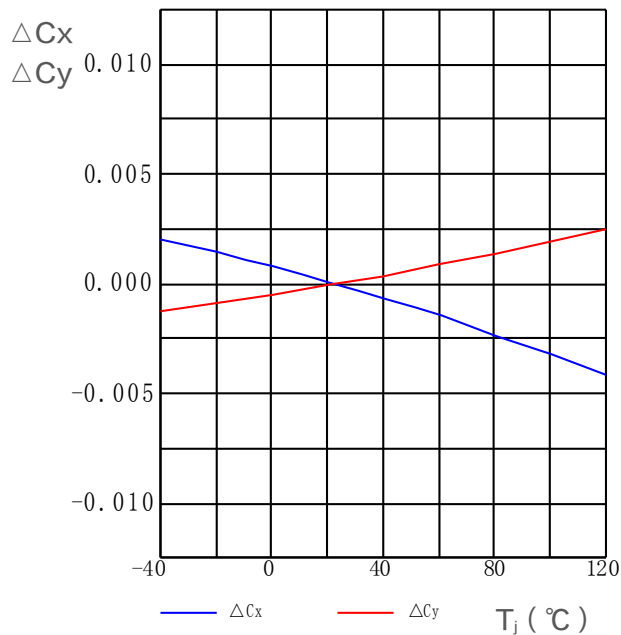

焊点温度与正向电流 / Solder Point Temperature vs. Forward Current

$I_f = f(T_s)$

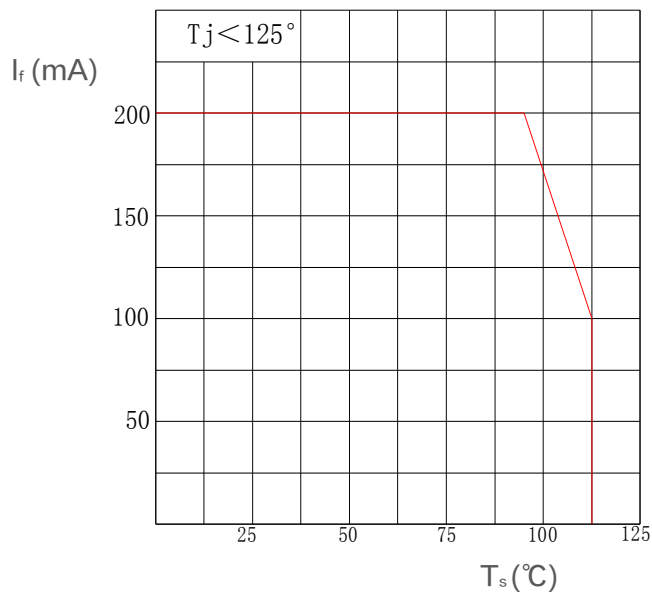

产品尺寸 / Package Outline

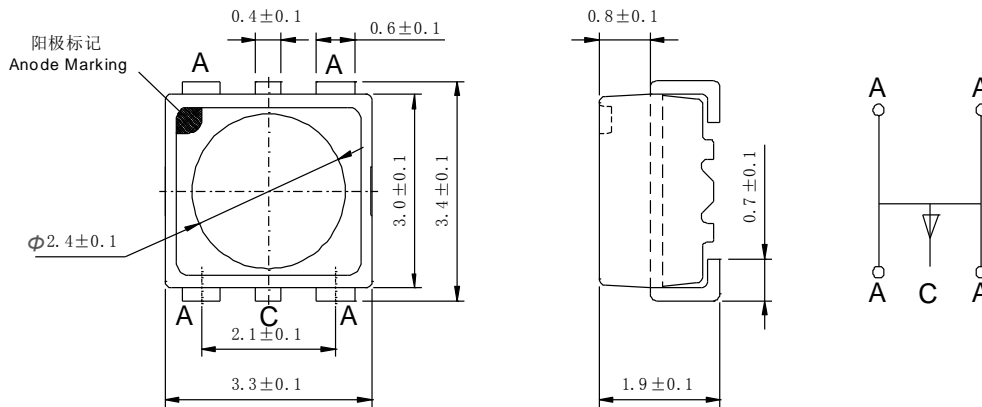

备注

- 统计质量: 40mg
- 标 记: 阳极
- 腐蚀试验: Class 3B
 - 测试条件: 1) H₂S 测试: 40°C / 90%R.H, 15ppm, 336小时 (标准IEC 60068-2-43)
 - 2) 流动混合气体测试: 25°C / 75 %R.H, 500小时
 - (标准IEC 60068-2-60 方法 4: 10ppb H₂S, 200ppb SO₂, 200ppb NO₂, 10ppb Cl₂)

NOTE

- Approximate Weight: 30mg
- Mark: Anode
- Corrosion test: Class 3B
 - Test conditions: 1) H₂S test: 40°C / 90%R.H, 15ppm, 336hours
 - (Standards IEC 60068-2-43)
 - 2) Flowing mixed gas test: 25°C / 75 %R.H, 500hours
 - (Standards IEC 60068-2-60 test method 4: 10ppb H₂S, 200ppb SO₂, 200ppb NO₂, 10ppb Cl₂)

推荐焊盘 / Recommended Solder Pad

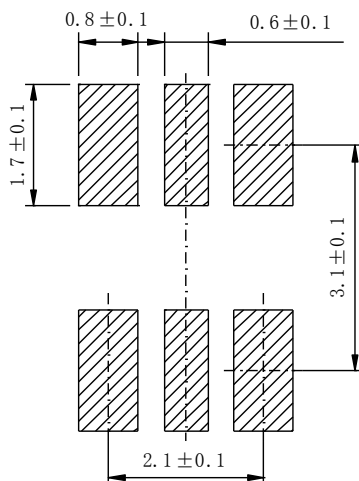

注释

- 不适合超声波清洗的封装

NOTE

- Package not suitable for ultrasonic cleaning

回流焊要求 / Reflow Soldering Profile

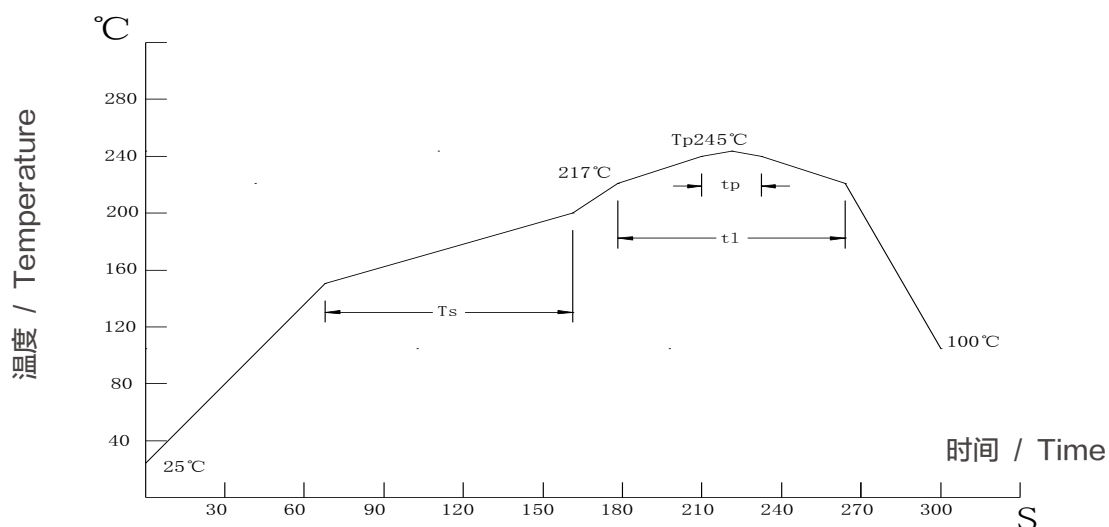

主要特性 Profile Feature	符号 Symbol	无铅焊接 Pb-Free (SnAgCu) Assembly			单位 Unit
		min.	rec.	max.	
预热升温速率 Ramp-up Rate to Preheat 25°C-150°C	-	-	2	3	°C/s
时间 / Time (T_{smin} to T_{smax})	T_s	60	100	120	s
峰值升温速率 Ramp-up Rate to Peak (T_{smax} to T_p)	-	-	2	3	°C/s
熔点温度 Liquidus Temperature	T_l	-	217	-	°C
高于熔点温度的时间 Time above Liquidus Temperature	t_l	-	80	100	s
峰值温度 / Peak Temperature	T_p	-	245	260	°C
规定的峰值温度 $\pm 5^\circ\text{C}$ 以内的时间 Time within 5°C of the Specified Peak Temperature	t_p	10	20	30	s
降温速率 / Ramp-down Rate (T_p to 100°C)	-	-	3	6	°C/s
时间 / Time (25°C to T_p)	-	-	-	480	s

卷带与卷盘 / Tape and Reel

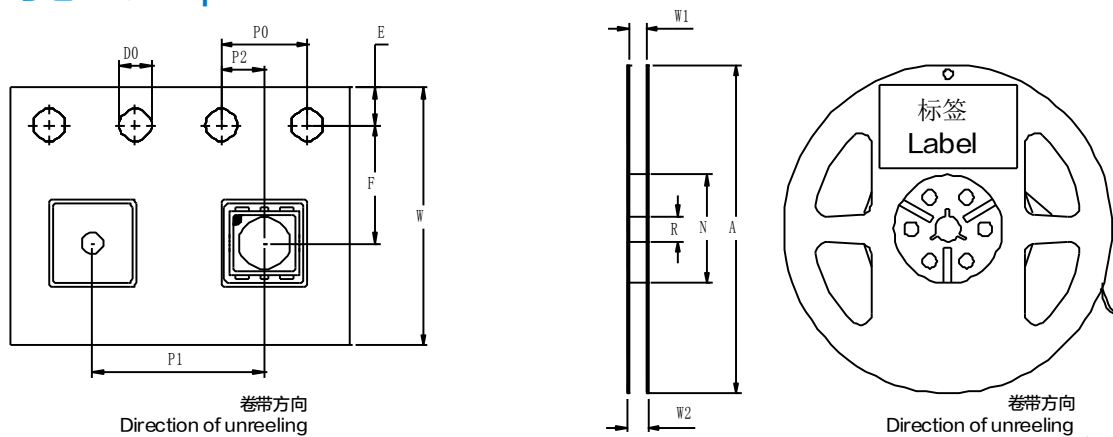

前端空带: 最小400 mm; 尾端空带: 最小160 mm; 尺寸符合: IEC 60286-3, EIA 481-D标准

Leader: min. 400 mm; Trailer: min. 160 mm; Requirement acc. to IEC 60286-3, EIA 481-D

卷带尺寸 / Tape Dimensions (mm)

W	P0	P1	P2	D0	E	F
8±0.1	4±0.1	4±0.1	2±0.05	1.5±0.1	1.75±0.1	3.5±0.05

卷盘尺寸 / Reel Dimensions (mm)

A	W1	W2	N	R
177.8	9.3±0.3	11.2±0.3	58.5±0.2	13.5±0.2

条形码标签 / Barcode-Product-Label (BPL)



包装材料及过程 / Dry Packing Process and Materials

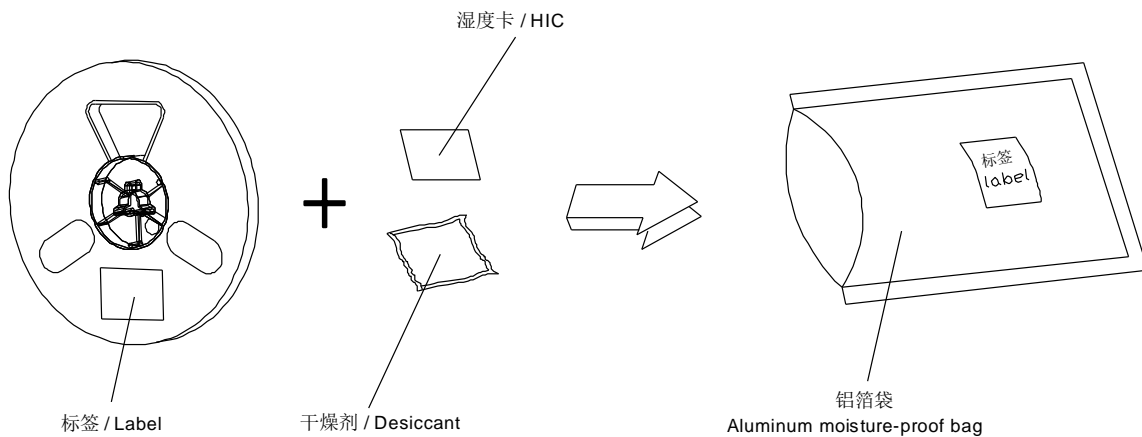

备注

产品包装在一个干燥的铝箔袋里，同时内附有干燥剂和湿度卡。
对于干燥包装，您可以从网络或JEDEC标准里获取。

NOTE

Moisture-sensitive product is packed in a dry bag containing desiccant and HIC (humidity indicator card).
Regarding dry pack you may find further information in the internet or JEDEC.

出货包装及材料 / Transportation Packing and Materials

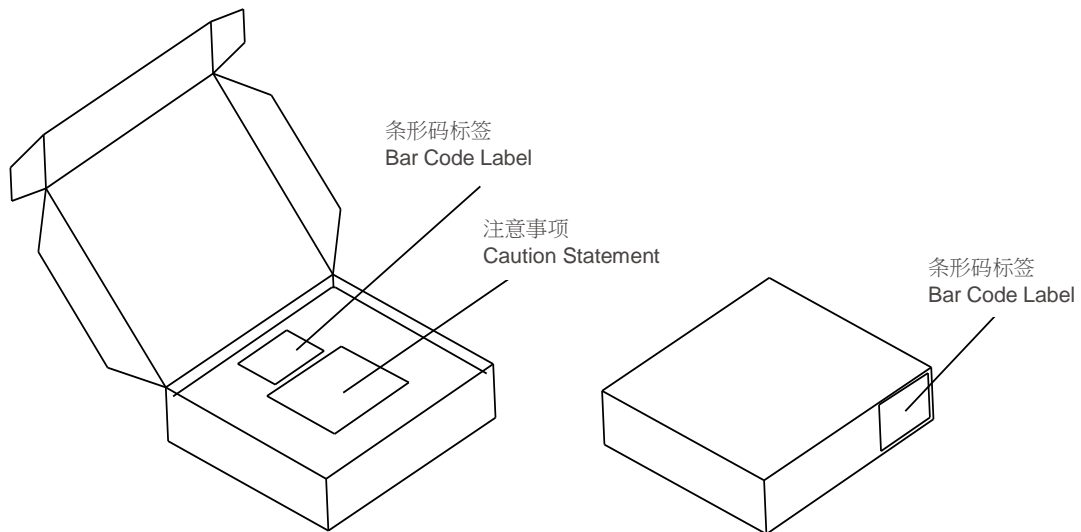

出货箱尺寸 / Dimensions of Transportation Box (mm)

宽度 / Width	长度 / Length	高度 / Height
256 ± 5	223 ± 5	62 ± 5
256 ± 5	223 ± 5	124 ± 5

注释

典型值: 每个产品的实际值可能与这些统计出的典型值不同。

公差: 除非图纸中有说明, 公差默认为 ± 0.1 mm。

正向电压: 正向电压是在8ms脉冲电流并且内部在线性为 ± 0.05 V和一个 ± 0.1 V的外在不确定性 (按照GUM K=3因子) 来进行测试的。

色度坐标: 色度坐标是在25ms脉冲电流并且内部在线性为 ± 0.005 和一个 ± 0.01 的外在不确定性 (按照GUM K=3因子) 来进行测试的。

亮度: 亮度是在25ms脉冲电流并且内部在线性为 $\pm 8\%$ 和一个 $\pm 11\%$ 的外在不确定性 (按照GUM K=3因子) 来进行测试的。

特殊声明: 本版本最终解释权归属鸿利智汇, 当中英文意思发生歧义时, 以中文为准。

Glossary

Typical Values: Actual values of each product may differ from these statistical values .

Tolerance of Measure: Unless otherwise noted in drawing, tolerances are specified with $+/-0.1$ mm.

Forward Voltage: The forward voltage is measured during a current pulse of typically 8 ms, with an internal reproducibility of ± 0.05 V and an expanded uncertainty of ± 0.1 V (acc. to GUM with a coverage factor of $k = 3$).

Chromaticity coordinate groups: Chromaticity coordinate groups is measured at a current pulse of typically 25 ms, with an internal reproducibility of ± 0.005 and an expanded uncertainty of ± 0.01 (acc. to GUM with a coverage factor of $k = 3$).

Brightness: Brightness values are measured during a current pulse of typically 25 ms, with an internal reproducibility of $\pm 8\%$ and an expanded uncertainty of $\pm 11\%$ (acc. to GUM with a coverage factor of $k = 3$).

Special Statement: The final interpretation of this specification shall be vested in Honglitronic, in the case of ambiguity, the Chinese version shall prevail.